





-  Hey Google
-  Hey Siri
-  Hey Alexa



**DOMOTICA**  
READY



**APP**  
CONTROL



**WIRELESS**  
REMOTE



**CORDED**  
CONTROL



**MANUAL**  
CONTROL

## FOREST DESIGN Series

The DS-XL® Series is designed to create visual impact and provides superior functionality and ease of use to the end-user. Available as manual, corded or motorised operated curtain track system.

- FOREST DS®
- FOREST DS-XL®
- FOREST DS-XL® Motorised
- FOREST DS-XL® LED
- FOREST DS-XL® LED Motorised

THE WORLD  
BEHIND  
YOUR  
CURTAINS



reddot winner 2021

# FOREST DS® - DESIGN SYSTEM



The DS® curtain track system is for fans of a sleek curtain track. This manually operated curtain track system fits into any stylish interior with an eye for design.

The DS® system has the same core dimension as the Klick System (KS®). This makes it possible to use all KS® assembly components (except the end caps).

The height of the track is 11 mm, and the curved elevation of the profile has an ergonomically designed extension to it so that the brackets can be mounted out of sight. Giving you a clean almost recess finish to your system when being utilised in a ceiling fix scenario.

## PRODUCT INFORMATION

- Elegant and aesthetically pleasing hand drawn track system.
- For all types of medium weight draperies (max. curtain weight 8kg per meter).
- Colours available: matt white, white, grey, anthracite, matt black, black.
- Available lengths in white: 4, 5, 6 & 7 meter (anthracite, matt white, matt black in 6 meter).
- Bendable, designer curtain track can be bent and reverse bent to a tight 10cm radius, or continuously curved using a 50cm radius.
- Matching assembly components for white, grey and black.
- Invisible ceiling brackets to fix track flush to ceiling available.
- Quick installation with "Smart Klick" brackets for wall and ceiling applications.
- Same brackets as used with Klick System.
- Heavy duty clickable carriers - UV protected - for smooth and easy traversing.
- Especially designed for use in combination with Forest Easyfold System for wave pleat application.
- Track finish: chromated powder coating with a factory applied patented dry lubricant.
- Warranty: 10 years.

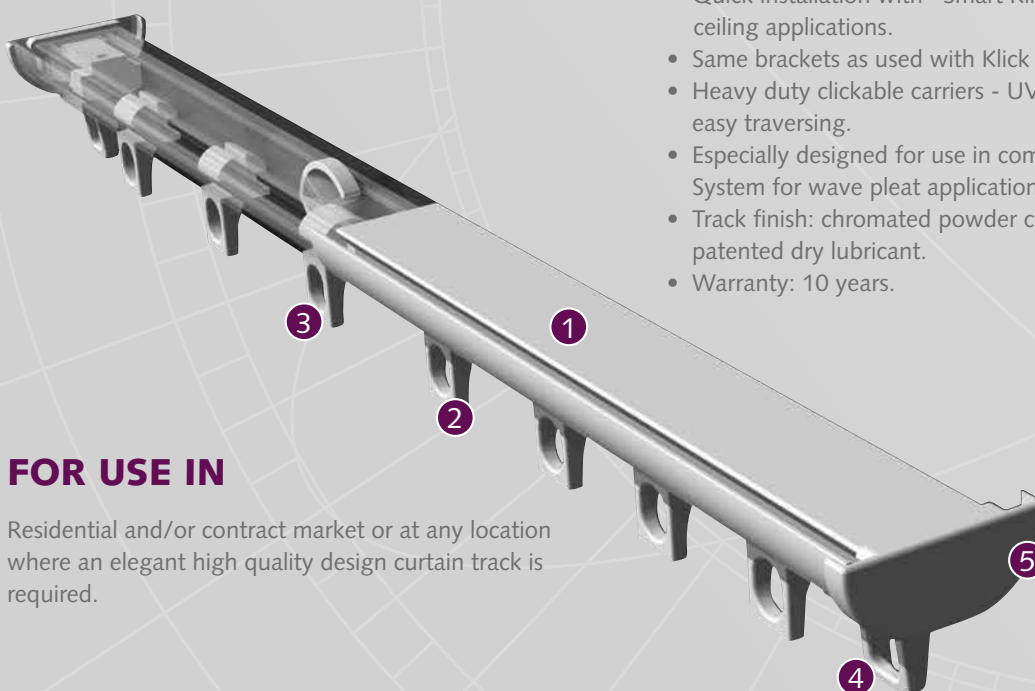

- 1 DS Track
- 2 DS Carrier
- 3 DS Stop carrier
- 4 DS Twist end stop
- 5 DS End cap

## FOR USE IN

Residential and/or contract market or at any location where an elegant high quality design curtain track is required.



## SPECIFICATIONS

- Shown actual size 1:1
- Weight: 170 gr/meter
- Aluminium Extrusion
- Size: 12 x 24 mm
- Colours: white, matt-white, grey, anthracite, black, matt-black

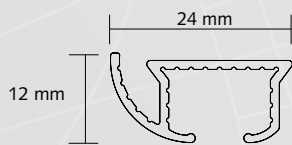

## BENDING / CURVING

The track can be bent and reverse bent using a 10cm radius. Continuous curving is available by special order from the factory only.

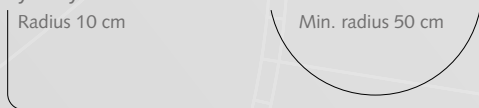

## APPLICATIONS

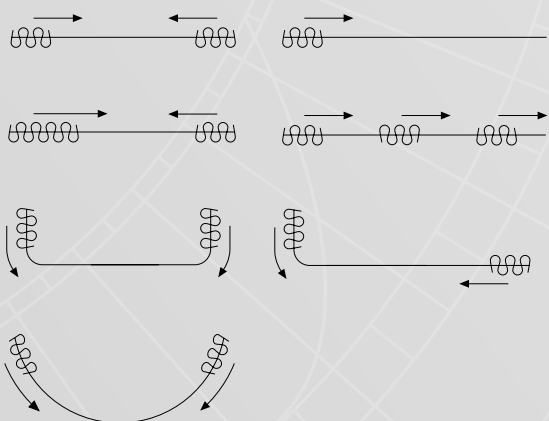

## MOUNTING

Smart Klick Aluminium wall bracket single

- A) 7,5 cm      B) 6,3 cm
- A) 10 cm      B) 8,8 cm

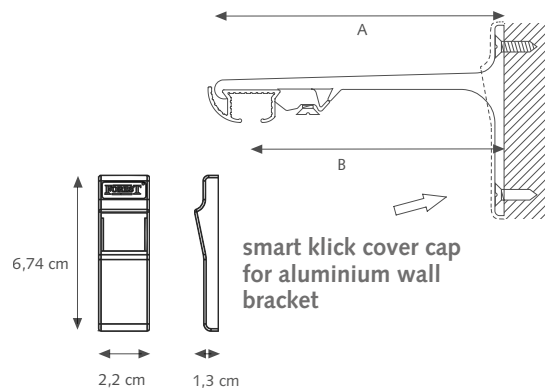

Smart Klick Aluminium wall bracket double

- A) 15 cm      B) 9,2 cm      C) 4,5 cm
- A) 20 cm      B) 9,2 cm      C) 9,5 cm

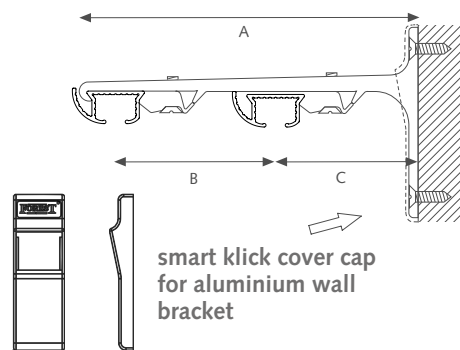

Smart Klick Aluminium wall bracket triple

- A) 25 cm      B) 9,3 cm      C) 5 cm

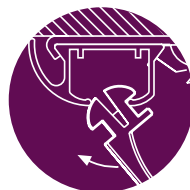
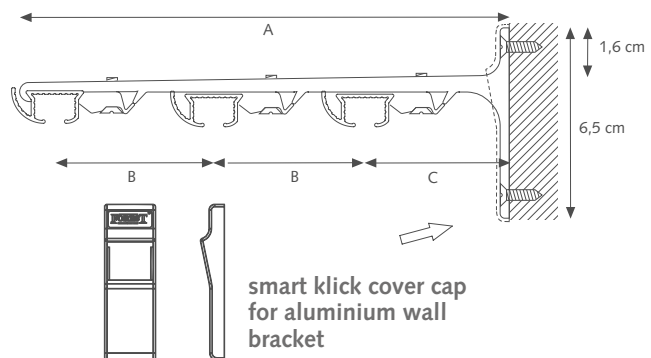

Clickable carrier



Clickable bracket



# FOREST DS-XL®



With the DS-XL® Series, Forest offers curtain tracks that optimally combines design and functionality. The Design System XL gives every interior an extra visual appearance.

Stylish curtains deserve an elegant and fashionable curtain track. The DS-XL® Series provide a sleek finish and contribute to a unique design look at home or in any hotelroom.

Thanks to a symmetrical profile, the system can be mounted "blind" to the ceiling. This provides an extra sleek finish. The track is easy to mount by means of swivel supports or click supports.

The DS-XL® track system has been especially designed for use with our wave system, Forest Easyfold System. But it is also suitable with regular pleated curtain headings.

## FOR USE IN

Hotels, offices, residences, boats, campers, planes or anywhere an efficient and elegant track system is required for curtains and drapes.

## PRODUCT INFORMATION

- Elegant and aesthetical hand drawn and corded curtain track system.
- For all types of medium weight draperies.
- Quick and easy installation.
- Ceiling brackets and wall brackets available.
- Invisible ceiling brackets to fix track flush to ceiling available.
- Heavy duty carriers - uv protected - for smooth and easy traversing.
- Colours available: white, grey or anthracite with matching assembly components.
- Available length: standard stock size 6 meter (19.8").
- Especially designed for use in combination with our wave pleat system 'Forest Easyfold System' .
- Warranty: 10 years.

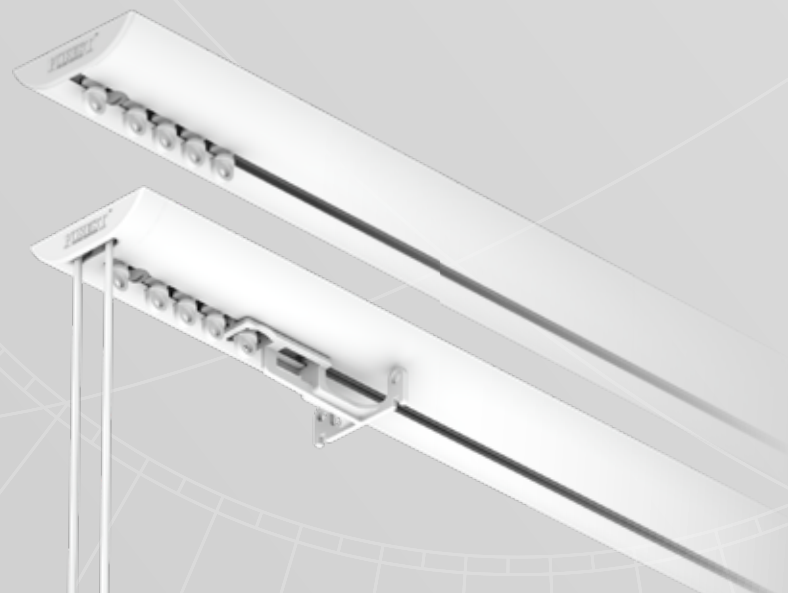

## PROFILE

- Shown actual size 1:1
- Weight: 480 gr/meter
- Aluminium extrusion
- Size: 60 x 15 mm
- Colours: white, grey, anthracite

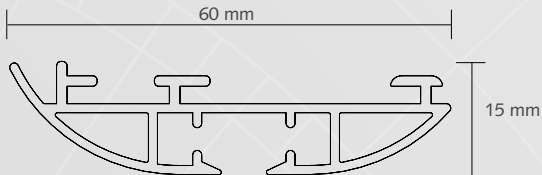

Easyflex tape application on DS-XL® track

## FOREST EASYFOLD SYSTEM

The forest wave series are an Additional feature of the drapery Hardware systems of forest group. It complies fully with the Contemporary demand for Round and fluent shapes in Decorative interiors.

It offers new possibilities for Applications in large and High spaces, such as lobbies, entrees, reception areas, conference rooms, auditoriums, meeting rooms, Food and beverage outlets etc.

The system can be installed onto all forest manual, corded (except cks) and Motorised tracks and curtain rod systems and gives a modern and special folding design to the curtain.

Such a modern curtain heading system Combined with a suitable fabric is Guaranteed to be a real eye-catcher In every room.

## EASYFLEX/EASYWAVE TOOL

With this tool you will be able to easily calculate your requirements of Easyflex carriers and Easyflex tape to obtain a beautiful folding curtain. Please scan the QR-code.



## COLOUR OPTIONS

DS-XL® is available in three colours: white, grey and anthracite.



# FOREST DS-XL® LED / Motorised



reddot winner 2021

This unique drapery system combines a stylish design with a unique way of lighting. Many designers will work with a lighting plan with three levels: High, especially if the ceiling is vaulted or has been finished with a special material; medium, which includes wall sconces; and low, which means floor lamps and other small lights. Our DS-XL® LED is the solution for a lighting plan on a higher level, integrating our track to create an overall glow on the ceiling.

The DS-XL® LED is an elegant system for all types of medium weight draperies. Available length up to 6 meter in 2 colours: timeless white and in a stylish anthracite finish, making it suitable to fit in every design.

## Create privacy

It also offers the possibility to illuminate the backside and/or the curtain track itself enabling a higher level of privacy.

## SUSTAINABLE LIGHTING

Traditional ways of lighting are very wasteful. Most of the power is wasted in the form of heat. This is why there has been a big push to change the environmental impact of lighting. Another benefit of LED lighting is sustainability and eco-friendliness. The system doesn't use toxic chemicals and it can last for years. It has a life span of approximately 30.000 hours.

## PRODUCT INFORMATION

- Hand drawn or motorised curtain track system
- Designer track for lighting and curtain track combined.
- Colours available: white and anthracite.
- Especially designed for Forest Wave application.
- Simple electrical installation by means of clickable connectors.
- Ceiling brackets and wall brackets available.
- Supplied with 1 LED strip.
- LED Colour temperature: warm white 3000.
- Low energy consuming LED strip, eco friendly.
- Dimmable LED strips (120 LED's per meter).
- LED lifespan of 30.000 hours.
- No soldering, clickable components for easy installation without the need for an electrician.
- Power: 10 watt/mtr.
- Energy label A+.
- The DS-XL® LED Motorised system can be integrated into any building automation system.
- The DS-XL® LED motorised track system can only be used with a Forest Shuttle® S motor.
- Warranty: 10 years (LED-lighting 2 years).





## DS-XL® LED MOTORISED

The DS-XL® LED Motorised track system is designed to create visual impact and provides superior functionality and ease of use to the end-user. Controlling the curtains and integrated LED-lighting by remote control or building automation system guarantees a unique experience of atmosphere and comfort in any room.



## RED DOT AWARD

The DS-XL® LED Motorised track system has been awarded for the Red Dot Award 2021 for its outstanding product design. The Red Dot Award is one of the most internationally known and sought-after awards in the design industry.



reddot winner 2021

## SPECIFICATIONS

- Shown actual size 1:1
- Size LED 61 x 20 mm
- Size LED Motorised 61 x 25 mm
- Weight LED 580 gr/meter
- Weight LED Motorised 675 gr/meter
- Aluminium extrusion
- Colours available: white or anthracite

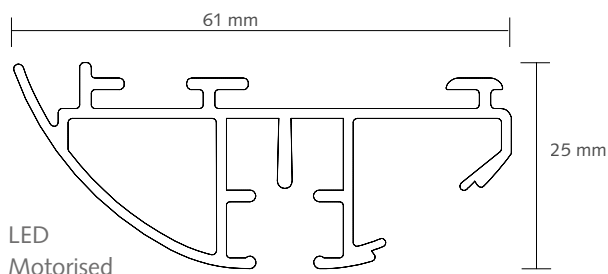
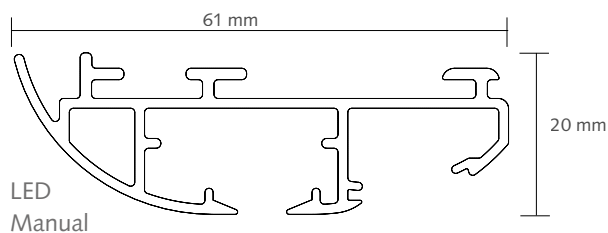

# FOREST DS-XL® LED Control Options

Our wide range of controls make finding a fit for your home even easier; controlling the curtains by hand, remote or even by building automation system. With the remote you can control the curtains in any position you like. Controlling the motorised curtain system by your smartphone or tablet, you can create and schedule customised room scenes that allow your curtains to operate on their own throughout the day.



## REMOTE CONTROL

We offer two types of RF remote controls: the EasyTouch and the Diamond Sense.

- The EasyTouch controls up to 6 systems, with the option to deactivate unused channels.
- The Diamond Sense is a 15- or 2-channel remote with an LED display. Systems can be operated manually or with the integrated timer. The LED display automatically lights up when your hand moves over it.

Both remotes have a range of up to 30 meters.



## APP CONTROL VIA FOREST WIFI-DONGLE

With the Shuttle® Wi-Fi dongle, you can control your motorised curtains with your mobile device by the Forest Connect app or even by voice command with the easy integration in for example Google Home or Amazon Echo without the need for an additional hub or gateway.



Scan for more info

## APP CONTROL VIA FOREST WIRELESS CONNECTOR

The Forest Wireless Connector provides an easy solution to make Forest motorised curtains 'smart.' When combined with a smart plug, you can effortlessly control the curtains through a mobile app. Controlling the motorised curtains system by your smartphone or tablet, you can create and schedule customized room scenes that allow your curtains to operate on their own throughout the day.

If you prefer to use the Forest Connect App, you can opt for Forest's smart plug. If you wish to operate your curtains with Apple HomeKit, Amazon Alexa, or Google Assistant, you will need a compatible third-party smart plug that works with these smart home apps. This RF device can also be seamlessly integrated into the most common building management systems, including systems with dry contacts.



## BUILDING AUTOMATION / HOTEL CONTROL

The DS-XL® System can be connected to any Building Automation system, by relay control.

## SMART DEVICE CONNECTIVITY

|   | Shuttle S/M/L  | Shuttle S/M/L with Z-Wave | Shuttle iOn | Shuttle AC     | Forest Connect app | Google Home    | Apple Homekit  | Amazon Alexa   | Google Assistant | Apple Siri     | Voice control  |
|---|----------------|---------------------------|-------------|----------------|--------------------|----------------|----------------|----------------|------------------|----------------|----------------|
| Forest Wireless Connector<br>One way transmitter to control curtains by third party apps or by Domotics. (433Mhz) | ●              |                           | ●           |                | ● <sup>1</sup>     | ● <sup>1</sup> | ● <sup>1</sup> | ● <sup>1</sup> | ● <sup>1</sup>   | ● <sup>1</sup> | ● <sup>1</sup> |
| Forest Wi-Fi Dongle in combination with Forest Connect app  | ●              | ●                         |             |                | ●                  | ●              |                | ●              | ●                | ●              |                |
| Smartwares Controller in combination with HomeWizard lite app (433 Mhz)   | ●              |                           | ●           |                |                    |                |                | ●              |                  |                |                |
| Homey in combination with Homey app   | ●              | ●                         | ●           |                |                    | ●              | ●              | ●              | ●                | ●              |                |
| FIBARO System in combination with FIBARO Home Center app  |                | ●                         |             | ● <sup>2</sup> |                    | ●              | ●              | ●              | ●                | ●              |                |
| Samsung SmartThings Hub in combination with Samsung SmartThings app   |                | ●                         |             |                |                    | ●              | ●              | ●              | ●                | ●              |                |
| 230 Volt hard-wired building management system  | ● <sup>3</sup> |                           |             | ●              |                    |                |                |                |                  |                |                |

1) In combination with a smart plug

2) Only with FIBARO Roller Shutter 3 / Walli Roller Shutter

3) In combination with an AC Control Set











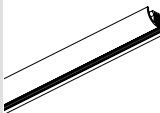

## WORKS WITH







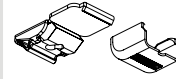
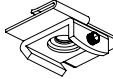
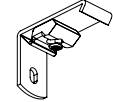
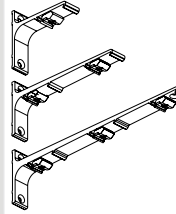



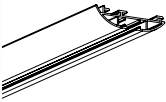

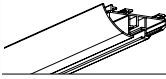
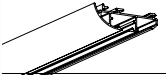
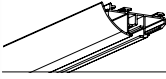



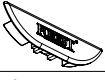



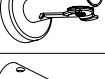

\* Only works with actor.









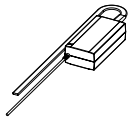
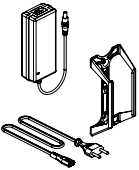

Forest DS-XL® (LED) is compatible with many other Building Automation systems, thanks to its modular construction. A competitive advantage over other motorised drapery systems in the world!

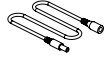
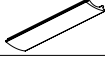

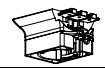
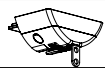

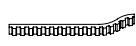

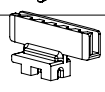
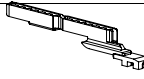

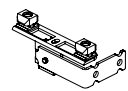
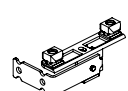
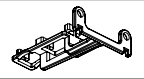
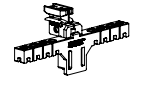
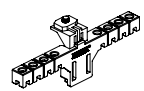
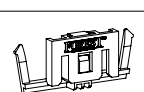











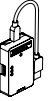

| DS | DS-XL | DS-XL<br>CORDED | DS-XL<br>MOTORISED | DS-XL LED | DS-XL LED<br>MOTORISED | DS TRACK +<br>COMPONENTS  | ARTICLE  | PACKING UNIT  | ART.NR   |  |
|----|-------|-----------------|--------------------|-----------|------------------------|---|--|---|--|--|
| ●  |       |                 |                    |           |                        |    | DS TRACK MATT WHITE<br>DS TRACK WHITE<br><br>DS TRACK GREY<br>DS TRACK ANTHRACITE<br>DS TRACK MATT BLACK<br>DS TRACK BLACK   | 120 mtr/bundle<br>80 mtr/bundle<br>100 mtr/bundle<br>120 mtr/bundle<br>140 mtr/bundle<br>120 mtr/bundle<br>120 mtr/bundle<br>120 mtr/bundle<br>120 mtr/bundle | 6 mtr<br>4 mtr<br>5 mtr<br>6 mtr<br>7 mtr<br>6 mtr<br>6 mtr<br>6 mtr<br>6 mtr                                    | 2001001600-MAT<br>2001001400-G<br>2001001500-G<br>2001001600-G<br>2001001700-G<br>2001003600-G<br>2001005600-G<br>2001006600-MAT<br>2001006600-G   |
| ●  |       |                 |                    |           |                        |    | TRACK CONNECTOR<br>For use of DS / KS / CKS  | 10/box  | white<br>grey<br>black   | 1018401010<br>1018403010<br>1018406010   |
| ●  |       |                 |                    |           |                        |    | INTERNAL DS PLASTIC TRACK CONNECTOR<br>Can be inserted in the track, but still allows the carrier to run over.   | 50/box  | white  | 2018400000-G   |
| ●  |       |                 |                    |           |                        |    | CARRIER ASYMMETRICAL<br>Clickable, UV-resistant plastic, 10 carriers on a breakaway strip. (also symmetrical carriers available).  | 500/box   | white<br>grey<br>black   | 1010001000<br>1010003000<br>1010006000   |
| ●  |       |                 |                    |           |                        |    | CARRIER SYMMETRICAL  | 500/box   | white  | 1010101000   |
| ●  |       |                 |                    |           |                        |    | STOP CARRIER<br>Clickable, UV-resistant plastic  | 250/box   | white<br>grey<br>black   | 2010201000<br>2010203000<br>2010206000   |
| ●  |       |                 |                    |           |                        |    | DS TWIST ENDSTOP WITH CAP<br>UV-resistant plastic with metal plate. "Twists" into track  | 100/box   | white<br>grey<br>black   | 2016301000<br>2016303000<br>2016306000   |
| ●  |       |                 |                    |           |                        |    | DS ENDCAP SHORT + SCREW<br>for one-way draw curtains   | 100/box   | white<br>grey<br>anthracite<br>black   | 2006001000<br>2006003000<br>2006005000<br>2006006000   |
| ●  |       |                 |                    |           |                        |   | DS ENDCAP UNIVERSAL + SCREW  | 100/box   | white<br>grey<br>anthracite<br>black   | 4816101000<br>4816103000<br>4816105000<br>4816106000   |
| ●  |       |                 |                    |           |                        |  | CEILING BRACKET<br>Slides onto the track, powder coated. Regular duty  | 100/box   | white<br>grey<br>black   | 1018001000<br>1018003000<br>1018006000   |
| ●  |       |                 |                    |           |                        |  | CEILING BRACKET WITH SLOT<br>Slides onto the track, powder coated. Regular duty<br>Slotted support makes fixing curtain track easier   | 100/box   | white<br>grey<br>black   | 1018101000<br>1018103000<br>1018106000   |
| ●  |       |                 |                    |           |                        |  | SMART KLICK CEILING BRACKET<br>Powder coated, "klicks" onto track.<br>Attach with VK-4 mm screw.<br><br>SMART KLICK CEILING BRACKET INCL. COVER CAP<br><br>COVER CAP FOR SMART KLICK BRACKETS<br>Suitable for Smart Klick Wall-and Ceiling bracket   | 100/box   | white<br>grey<br>black<br><br>white<br>grey<br>anthracite<br>black<br><br>white<br>grey<br>anthracite<br>black   | 1018201000<br>1018203000<br>1018206000<br><br>1018201001<br>1018203001<br>1018204001<br>1018206001<br><br>1019201000<br>1019203000<br>1019204000<br>1019206000   |
| ●  |       |                 |                    |           |                        |  | FALSE CEILING BRACKET (METAL)<br>For installation on to a suspended ceiling.<br>The track can be fixed in any angle.   | 25/box  | white  | 4519001000   |
| ●  |       |                 |                    |           |                        |  | SMART KLICK WALL BRACKET 3,5 cm<br>"Klicks onto track, powder coated. One screw attachment. For light weight use only.<br>SMART KLICK WALL BRACKET 6 cm<br>"Klicks onto track, powder coated. One screw attachment. For light weight use only.<br>SMART KLICK WALL BRACKET 7,5 cm<br>"Klicks onto track, powder coated. One screw attachment. For light weight use only.   | 50/box  | white<br>grey<br>black<br><br>white<br>grey<br>black<br><br>white<br>grey<br>black                               | 1020201035<br>1020203035<br>1020206035<br><br>1020201060<br>1020203060<br>1020206060<br><br>1020201075<br>1020203075<br>1020206075   |
| ●  |       |                 |                    |           |                        |  | ALUMINIUM SK WALL BRACKET 7,5 CM SINGLE.<br>"Klicks onto track, powder coated.<br><br>ALUMINIUM SK AFSTANDSTEUN 10 cm ENKEL.<br>"Klicks onto track, powder coated.<br><br>ALUMINIUM SK AFSTANDSTEUN 15 cm DUBBEL.<br>"Klicks onto track, powder coated.<br><br>KS ALUMINIUM SK AFSTANDSTEUN 20 cm DUBBEL.<br>"Klicks onto track, powder coated.<br><br>ALUMINIUM SK AFSTANDSTEUN 25 cm TRIPLE.<br>"Klicks onto track, powder coated. | 20/box<br><br>20/box<br><br>15/box<br><br>15/box<br><br>10/box  | white<br>grey<br>black<br><br>white<br>grey<br>black<br><br>white<br>grey<br>black<br><br>white<br>grey<br>black | 1020301075<br>1020303075<br>1020306075<br><br>1020301100<br>1020303100<br>1020306100<br><br>1020301150<br>1020303150<br>1020306150<br><br>1020301200<br>1020303200<br>1020306200<br><br>1020301250<br>1020303250<br>1020305250 |
| ●  |       |                 |                    |           |                        |  | SMART KLICK COVER CAP ALUMINIUM BRACKET<br>UNIVERSAL   | 50/box  | white<br>grey<br>black   | 1021301000<br>1021303000<br>1021306000   |

| DS | DS-XL | DS-XL<br>CORDED | DS-XL<br>MOTORISED | DS-XL LED | DS-XL LED<br>MOTORISED | DS-XL/ DS-XL<br>LED/ DS-XL (LED)<br>MOTORISED +<br>COMPONENTS                       | ARTICLE  | PACKING<br>UNIT  |                                  | ART.NR   |
|----|-------|-----------------|--------------------|-----------|------------------------|---|--|------------------|----------------------------------|--|
|    | ●     | ●               |                    |           |                        |    | DS-XL TRACK, 6 mtr   | 24mtr/<br>bundle | white<br>grey<br>anthracite      | 3916101600<br>3916103600<br>3916105600                       |
|    |       |                 |                    |           |                        |    | DS-XL RAIL, 4 mtr  |                  | white<br>anthracite              | 5917501400<br>5917506400                                     |
|    |       |                 | ●                  |           |                        |    | DS-XL TRACK MOTORISED, 6 mtr<br>In combination with Shuttle L motor  | 6mtr/bundle      | white<br>anthracite              | 5915501600<br>5915505600                                     |
|    |       |                 |                    | ●         |                        |    | DS-XL LED TRACK MANUAL   | 6mtr/length      | white<br>anthracite              | 5917501600<br>5917505600                                     |
|    |       |                 |                    |           | ●                      |    | DS-XL LED TRACK MOTORISED,<br>6 mtr. In combination with Shuttle S<br>motor & the Shuttle M adaptor                                | 6mtr/length      | white<br>anthracite              | 5915501600<br>5915505600                                     |
|    | ●     | ●               | ●                  | ●         | ●                      |    | ECONOMY CARRIER SMALL  | 500/box          | white<br>grey<br>black           | 3910101000<br>3910103000<br>3910106000                       |
| ●  |       |                 | ●                  |           | ●                      |    | END STOP UNIVERSAL METAL<br>Suitable for DS, DS-XL (LED) motorised with pinch pleat  | 100/box          | matt white<br>grey<br>matt black | 8880001000<br>8880003000<br>8880006000                       |
|    | ●     | ●               |                    | ●         |                        |    | DS-XL ENDSTOP<br>To use in combination with adjustable wave carrier<br>Easyflex. For center draw curtains                          | 100/box          | white<br>grey<br>black           | 3916001000<br>3916003000<br>3916006000                       |
|    | ●     |                 |                    |           |                        |    | DS-XL ENDCAP   | 20/box           | white<br>grey<br>black           | 3916101000<br>3916103000<br>3916106000                       |
|    |       | ●               |                    |           |                        |   | DS-XL ENDCAP CORDED<br>metal   | 20/box           | white<br>grey<br>anthracite      | 3916201001-ZA<br>3916203001-ZA<br>3916205001-ZA              |
|    |       |                 |                    | ●         |                        |  | DS-XL LED ENDCAP   | 20/box           | white<br>black                   | 5916501000<br>5916506000                                     |
|    |       |                 |                    | ●         |                        |  | DS-XL LED END CAP FLAT   | 20/box           | white<br>black                   | 5916501002<br>5916506002                                     |
|    | ●     | ●               | ●                  | ●         | ●                      |  | DS-XL KLICK CEILING BRACKET  | 100/box          |                                  | 3918301000   |
|    | ●     | ●               | ●                  | ●         | ●                      |  | DS-XL CEILING SWIVEL BRACKET   | 100/box          | white<br>anthracite              | 3818200230<br>3818205230                                     |
|    | ●     | ●               | ●                  | ●         | ●                      |  | WALL BRACKET 9 CM  | 5/box            | white<br>anthracite              | 3820001018<br>3820005018                                     |
|    | ●     | ●               | ●                  | ●         | ●                      |  | WALL BRACKET EXTENSION 4 CM  | 10/box           | white<br>anthracite              | 5815201030<br>5815205030-PC                                  |
|    | ●     | ●               | ●                  | ●         | ●                      |  | DS-XL TRACK CONNECTOR STRAIGHT   | 10/box           |                                  | 3916401000   |
|    | ●     |                 |                    | ●         |                        |  | DS-XL TRACK CONNECTOR 90°  | 10/box           |                                  | 3916401001   |
|    |       |                 |                    | ●         | ●                      |  | DS-XL LED STRIP<br>3000K/ 24V/ 10W/m<br>8mm width  | 50mtr/roll       |                                  | 5917503055   |
|    |       |                 |                    | ●         | ●                      |  | DS-XL LED STRIP CONNECTOR CABLE FOR DIMMER,<br>EXTENSION CABLE<br>35 cm / 24Vdc<br>35 cm / 24Vdc<br>200cm / 24Vdc<br>200cm / 24Vdc | 1/piece          | white<br>black<br>white<br>black | 5917502431-A<br>5917502432-A<br>5917502421-A<br>5917512422-A |
|    |       |                 |                    | ●         | ●                      |  | DS-XL LED-STRIP CONNECTOR CABLE FOR ADAPTOR<br>200cm / 24Vdc<br>200cm / 24Vdc<br>35 cm / 24Vdc<br>35 cm / 24Vdc                    | 1/piece          | white<br>black<br>white<br>black | 5917502521<br>5917502522<br>5917502531<br>5917502532         |
|    |       |                 |                    | ●         | ●                      |  | DS-XL LED RF DIMMER<br>In combination with Shuttle M adaptor<br>To control LED light via Forest remote/wall switch                 | 1/box            | white<br>black                   | 5917531470<br>5917536470                                     |
|    |       |                 |                    | ●         | ●                      |  | DS-XL LED WIFI DIMMER<br>In combination with Shuttle M adaptor<br>To control LED light<br>via Forest Connect App                   | 1/box            | white<br>black                   | 5917541000<br>5917546000                                     |

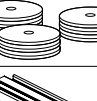

| DS | DS-XL | DS-XL<br>CORDED | DS-XL<br>MOTORISED | DS-XL LED | DS-XL LED<br>MOTORISED | DS-XL/ DS-XL<br>LED/ DS-XL (LED)<br>MOTORISED +<br>COMPONENTS                       | ARTICLE  | PACKING<br>UNIT  | ART.NR   |  |
|----|-------|-----------------|--------------------|-----------|------------------------|---|--|--|--|--|
|    |       |                 |                    |           |                        |    | ADAPTOR SET SHUTTLE M - FOR EU, UK AND USA<br>(icm DS-XL LED Dimmer) Incl. cable & holder<br>EU 0.50 mtr<br>EU 3.00 mtr<br>UK 0.50 mtr<br>USA 0.50 mtr<br>EU 0.50 mtr  | 1/box<br><br>white<br>white<br>white<br>white<br>black | 5201002002<br>5201002003<br>5201002004<br>5201002007<br>5201006002 |  |
|    |       |                 |                    |           |                        |    | ADAPTOR SET SHUTTLE M - FOR AUSTRALIA<br>Items to be ordered separately<br>FOREST ADAPTOR 24 VOLT DC<br>(UNIVERSAL, EXCL CABLE)<br>WALL BRACKET FOR POWER SUPPLY 5201002000<br>POWER CABLE FOR SHUTTLE L & S<br>AUS 1.80 mtr | 1/box<br>1/box<br>1/box                                | 5201002000<br>5201002001<br>5201001141                             |  |
|    |       |                 |                    |           |                        |    | SPLITTER CABLE 1XC8/2XC7 50 CM<br>ith the splitter cable, only one power outlet is needed to<br>power both the Shuttle motor and the DS-XL LED RF<br>Dimmer/DS-XL LED Wifi Dimmer  | 1/box  | white<br>black<br>5205911050<br>5205916050                         |  |
|    |       |                 |                    |           |                        |    | SWITCHING POWER SUPPLY DC EXTENSION CABLE<br>for Shuttle S/M power supply in combination with<br>DS-XL LED Dimmer  | 1/box  | 2 meter<br>/white  | 5209002200   |
|    |       |                 |                    |           |                        |    | DS-XL LED STRIP ANTHRACITE<br>To cover the LED-channel when not in use   | 6mtr/bundle  | anthracite   | 5916505000   |
|    |       |                 |                    |           |                        |    | DS-XL LED STRIP MOUNTING DEVICE  | 1/box  |  | 5916509999   |
|    |       |                 |                    |           |                        |    | DS-XL LED MOTORISED MOTOR PULLEY, 6 mtr<br>plastic   | 1/box  | white<br>black   | 5917011000<br>5917076000                             |
|    |       |                 |                    |           |                        |   | DS-XL LED MOTORISED RETURN PULLEY, 6 mtr<br>plastic  | 1/box  | white<br>black   | 5917011100<br>5917016100                             |
|    |       |                 |                    |           |                        |  | DS-XL LED MOTORISED MOTOR- AND RETURN PULLEY<br>SET metal  | 1/box  | white<br>anthracite  | 5917011000-SET<br>5917015000-SET                     |
|    |       |                 |                    |           |                        |  | FMS TRANSPORT BELT<br>Toothed belt, to be installed inside the FMS Track   | 100mtr/roll  |  | 5105501000   |
|    |       |                 |                    |           |                        |  | FMS BELT CONNECTOR<br>Connects the Master Carrier with the transport belt  | 50/box   | white<br>grey<br>black   | 5103011500<br>5103013500<br>5103016500               |
|    |       |                 |                    |           |                        |  | WAVE BELT CONNECTOR CENTER DRAW<br>For use with wave pleat curtains (Easyflex)<br>To use in combination with adjustable wave carrier   | 50/box   | white<br>grey<br>black   | 4813001040<br>4813003040<br>4813006040               |
|    |       |                 |                    |           |                        |  | WAVE BELT CONNECTOR ONE-WAY DRAW<br>For use with wave pleat curtains (Easyflex)<br>To use in combination with adjustable wave carrier  | 50/box   | white<br>grey<br>black   | 4813001030<br>4813003030<br>4813006030               |
| DS | DS-XL | DS-XL<br>CORDED | DS-XL<br>MOTORISED | DS-XL LED | DS-XL LED<br>MOTORISED | FOREST WAVE<br>COMPONENTS   | ARTICLE  | PACKING<br>UNIT  | ART.NR   |  |
|    |       |                 |                    |           |                        |  | WAVE DS ENDCAP + SCREW<br>To be screwed with an Easywave carrier,<br>made of UV-resistant plastic for wave   | 100/box  | white<br>grey<br>black   | 4816101000<br>4816103000<br>4816106000               |
|    |       |                 |                    |           |                        |  | EASYFLEX MASTER CARRIER 90 DEGREE LEFT for<br>center draw in combination with master carrier right<br>90° left for small stiffener   | 25/box   | white<br>grey<br>black<br>white                                    | 4815351090<br>4815353090<br>4815356090<br>4815361090 |
|    |       |                 |                    |           |                        |  | EASYFLEX MASTER CARRIER 90 DEGREE RIGHT for<br>center draw in combination with master carrier left<br>90° right for small stiffener  | 15/box   | white<br>grey<br>black<br>white                                    | 4815451090<br>4815453090<br>4815456090<br>4815461090 |
|    |       |                 |                    |           |                        |  | EASYFLEX PLASTIC MASTER CARRIER<br>90 DEGREE   | 15/box   | white<br>black   | 3916701000<br>3916703000<br>3916706000               |
|    |       |                 |                    |           |                        |  | WAVE ADJUSTABLE MASTER CARRIER<br>For use with wave pleat curtains (Easyflex).<br>Height adjustable and blocks detachable for<br>the correct wave pleat depth.   | 25/box   | white<br>black   | 4813001050<br>4813006050                             |
|    |       |                 |                    |           |                        |  | WAVE ADJUSTABLE ENDSTOP<br>For use with wave pleat curtains (FES). Height<br>adjustable and blocks detachable for the correct<br>wave pleat depth. For DS-XL (LED) motorised,<br>only suitable with a metal return pulley.   | 25/box   | white<br>black   | 4816001001<br>4816006001                             |
|    |       |                 |                    |           |                        |  | WAVE ADJUSTABLE HOOK FOR MOTOR<br>For use with wave pleat curtains (Easyflex).<br>For DS-XL (LED) motorised, only suitable with<br>a metal return pulley.  | 25/box   | white<br>black   | 4813001010<br>4813006010                             |



| DS | DS-XL | DS-XL<br>CORDED | DS-XL<br>MOTORISED | DS-XL LED | DS-XL LED<br>MOTORISED | CONTROL<br>COMPONENTS +<br>OTHER ITEMS  | ARTICLE   | PACKING UNIT        |                          | ART.NR   |
|----|-------|-----------------|--------------------|-----------|------------------------|---|---|---------------------|--------------------------|--|
|    |       | ●               |                    |           |                        |                    | DS-XL CORD CONNECTOR  | 100/box             | white<br>black           | 1530301000<br>1530306000   |
|    |       | ●               |                    |           |                        |                    | TRAVERSE CORD - Polyester drapery cord designed for strong smooth slide, Ø 3.5 mm (0,14"), 16 ply. Suitable for CKS/CCS/CRS/DS-XL Corded  | 250 mtr/roll        | white<br>grey<br>black   | 1030401000<br>1030403000<br>1030406000                           |
|    |       | ●               |                    |           |                        |                    | TENSION PULLEY  | 25/box              | white                    | 1030501000   |
|    |       | ●               |                    |           |                        |                    | CORD/CHAIN WALL MOUNT SAFETY BOX SINGLE   | 25/box              |                          | 3645702000   |
|    |       | ●               |                    |           |                        |                    | CORD/CHAIN WEIGHT DESIGN<br>110 GR WIT  | 10/box              | white<br>grey<br>black   | 3030701000<br>3030703000<br>3030706000                           |
|    |       |                 | ●                  | ●         | ●                      |                    | FOREST EASYTOUCH REMOTE CONTROL<br>6-channel. Equipped with the original RF protocol and Forest Link® protocol.<br>Excl. Wall holder. Works with all Shuttle motors   | 1/box               | matt white<br>matt black | 5201081006<br>5201086006   |
|    |       |                 | ●                  | ●         | ●                      |                    | FOREST EASYTOUCH WALL HOLDER<br>Only suitable for EasyTouch remote control (soon available)   | 1/box               | transparent              | 5201080000   |
|    |       |                 | ●                  | ●         | ●                      |                    | FOREST DIAMOND SENSE REMOTE CONTROL   | 1/box               | white<br>black           | 5201091470<br>5201096470   |
|    |       |                 | ●                  | ●         |                        |                    | FOREST WIFI DONGLE<br>Incl. cable. WiFi 2,4GHz. Bidirectioneel<br>Power supply 12V DC 300mA max<br>USB power 5V DC 1000mA max<br>Control the curtains with Forest Connect App                                       | 1/box               | white<br>black           | 5201002280<br>5201006280   |
|    |       |                 | ●                  | ●         |                        |                  | FOREST WIRELESS CONNECTOR<br>Incl. 15cm USB cable, excl. usb-adaptor<br>One way transmitter to control curtains by third party apps (i.e Google/Apple /Amazon) or by Domotics                                       | 1/box               | white                    | 5201002270   |
|    |       |                 | ●                  | ●         |                        |                  | FOREST WIRELESS CONNECTOR USB ADAPTOR   | 1/box               | EU<br>UK<br>AU<br>US     | 5201002271-EU<br>5201002271-UK<br>5201002272-AU<br>5201002274-US |
|    |       |                 | ●                  | ●         |                        |                  | FOREST SMART PLUG WHITE<br>The Forest Smart Plug allows App control via the Forest Connect App (the Forest Wireless Connector is required)  | 1/box               | EU<br>UK<br>AU<br>US     | 5201001952-EU<br>5201001953-UK<br>5201001954-AU<br>5201001955-US |
|    |       |                 | ●                  | ●         |                        |                  | FOREST WIRELESS WALL SWITCH<br>2-channel wall switch<br>Sizes: 8.5 x 8.5 x 1 cm   | 1/box               | white<br>black           | 5201001480<br>5201006480   |
|    |       |                 |                    |           |                        | <b>BENDING<br/>COMPONENTS</b>   | <b>ARTICLE</b>  | <b>PACKING UNIT</b> |                          | <b>ART.NR</b>  |
|    |       | ●               |                    |           |                        |                  | COMPACT BENDING HOUSE<br>For DS / KS / CRS  | 1/piece             |                          | 1050000000   |
|    |       |                 |                    |           |                        |                  | DS BENDING WHEEL ALL-IN incl. strips (60cm)   | 1/piece             |                          | 2050000000   |
|    |       | ●               |                    |           |                        |                  | ELECTRIC POWERED BENDER<br>For creating continuous curves.<br>Minimum radius 50 cm.   | 1/box               | 230V<br>110V             | 1060500000<br>1060500001   |
|    |       | ●               |                    |           |                        |                  | DS BENDING WHEELS<br>Set of 3 bending wheels for electric powered bender.<br>Only suitable for DS track.  | 1/set               |                          | 2060700000   |
|    |       | ●               |                    |           |                        |                  | DS T-BENDING STRIP SET ELECTRIC<br>For DS electric powered bender,<br>Length of 60 cm.  | 1/piece             | 7m                       | 8500000000   |
|    |       | ●               |                    |           |                        |                  | KS/DS BENDING CASE - Box for storing all components of the compact bending tool, including accessories such as strips and bending wheels for the DS system. Dimensions: 40x30x33.5 cm. Box excludes all components. | 1/piece             |                          | 1050000001   |
|    |       | ●               | ●                  |           |                        | sample image<br> | ELECTRIC POWERED RAILCUTTER - 230 Volt EU   | 1/piece             |                          | 1061100000   |
|    |       |                 |                    |           |                        |                  | BLADE FOREST CUTTER NEW MODEL   | 1/piece             |                          | 1061200001   |
|    |       |                 |                    |           |                        |                  | TAFEL DISPLAY KS-DS-DS-XL   | 1/stuk              |                          | 9902100002   |