



EN

NL

DE

FR

INSTALLATION MANUAL **FOREST SHUTTLE® ION**

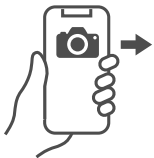

online help
page



instructional
video

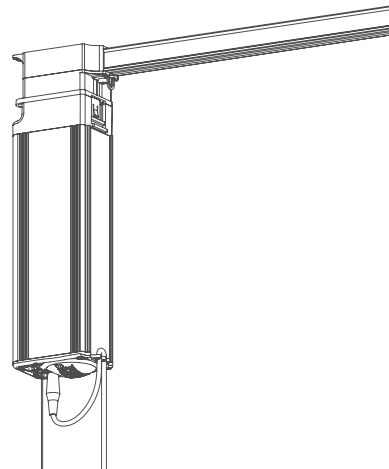



EU Declaration of Conformity

Hereby we, the undersigned:

Manufacturer: Forest Group Nederland B.V.
 Address; city, Country: Teugseweg 42, 7418 AM Deventer, The Netherlands
 Telephone number: +31 0570 622850

Declare that this DoC is issued under our sole responsibility and that this product is:

Product description: Electronic motorized curtain track system
 Type designation(s): Shuttle iOn
 Trademark: Forest
 Power Adapter: KS39DU-1680100CE

Object of the declaration:

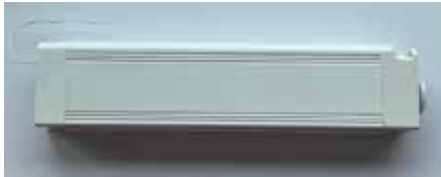

EN

The object is in conformity with the relevant Union harmonization legislation:

<input checked="" type="checkbox"/>	<u>Radio Equipment Directive – 2014/53/EU</u>	<input checked="" type="checkbox"/>	Article 3.2
<input checked="" type="checkbox"/>	Article 3.1(a)		EN 300 220-1 V3.1.1 (2017-02)
	EN 62368-1:2014 + A11:2017		EN 300 220-2 V3.1.1 (2017-02)
<input checked="" type="checkbox"/>	Article 3.1(b)		
	EN 301 489-1 V2.2.3 (2019-11)		
	EN 301 489-3 V2.1.1 (2019-03)		
	EN 55032:2015 + A11:2020 / EN 55035:2017 + A11:2020		
	EN IEC 61000-3-2:2019 + A1:2021 / EN 61000-3-3:2013 + A2:2021		
<input checked="" type="checkbox"/>	RoHS directive – 2011/65/EU + amendment (EU) 2015/863		

Signed for and on behalf of:

Place: Deventer

Name: A.G. ten Have

Date: 21 August 2024

Function: Head R&D

Signature:

Installing the FOREST SHUTTLE® iOn:

- 1 Assemble the track;
- 2 Install the brackets and fix the track onto the brackets;
- 3 Do not attach the drapery yet; Attach the drapery only after the end positions have been set.
→ position the master carrier(s) into half open position
- 4 Attach the Shuttle® iOn motor to the track;

⚠ Note: Remove the battery before connecting the Shuttle® iOn motor to the curtain track.

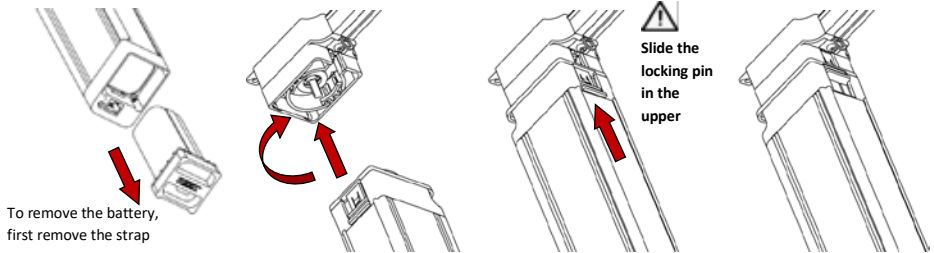

- 5 Insert the battery;

⚠ Remove the security cap from the battery and insert the battery, push until a "click" is heard.

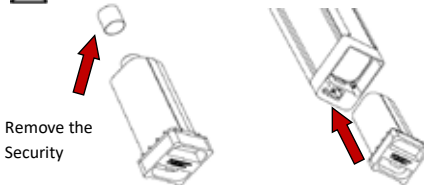

- 6 Setting the end limits of the FOREST SHUTTLE® iOn;



The stack back (adjusted open limit) can be set by remote or switch. For programming see page 6.

SETTING MOTOR DIRECTION AND CLOSE LIMIT:

The Shuttle® detects automatically the motor direction. By pulling the master carrier(s) towards closed position first, the Shuttle® will automatically learn that motor direction. The master carrier will travel automatically towards the closed position.

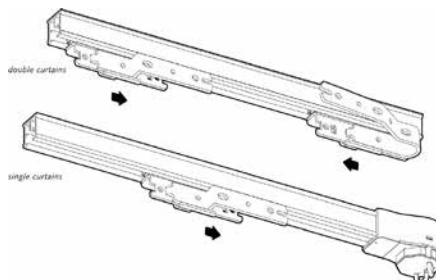

SETTING OPEN LIMIT:

When the closed position is reached, the master carrier(s) will automatically move towards the open position.

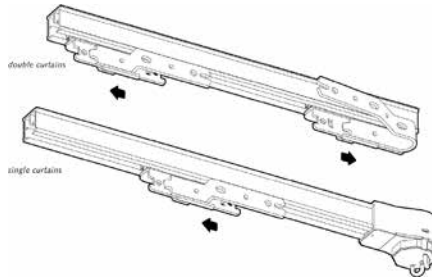

Stack back: When the master carrier reaches the fully open position it will stop (yellow LED4 is on). Now the open limit setting can be adjusted by hand, by remote or dry contact input. When the master carrier is not moved for 10 seconds, the yellow LED4 will go off and the open limit is set. The minimal automatic adjustment is 3 cm (1.2").

If you are not satisfied with the programmed end limits, then re-set the end limits as shown in the configuration table on page 6 and proceed from step 4.

7

Pair the Shuttle® iOn with a remote control;

All Forest RF remotes* can be paired to the Shuttle® iOn by activating the RF learning mode on the Shuttle® iOn and pressing the Open button on the remote.

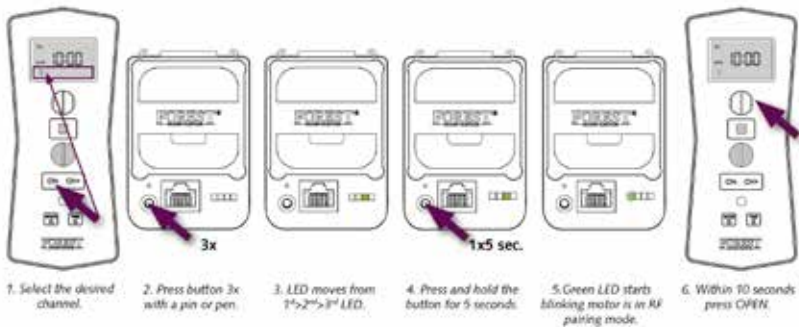

*Diamond Sense: version V2 and later

Shuttle® iOn Battery:

 **When the battery is getting low, the Shuttle® iOn motor will begin to operate more slowly, (6 cm/s – 2,36"/s), this is an indication to re-charge the battery.**

Charging the battery:

Take out the battery from the Shuttle® iOn motor and connect the charger to the battery as pictured below:

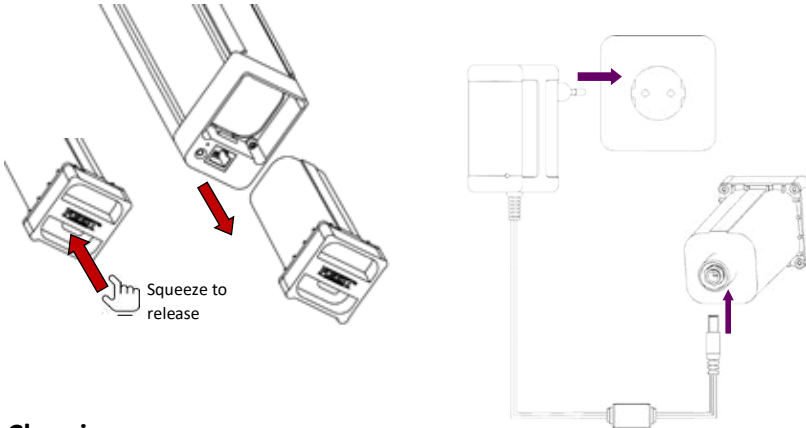

Charging:

The charger is equipped with a LED indicator on the front side, this LED indicates the actual charging status.

LED Orange:	LED Green:
Battery is charging	Battery is fully charged

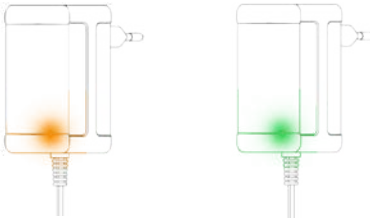

- Charging time battery is 5 hours;
- Do not use third party battery chargers;
- Do not attempt to repair the charger if damaged; replace the charger in this case;
- Do not charge the battery in humid conditions;
- Replace charger if damaged;
- Do not expose the battery pack to direct sunlight while charging;
- Do not repair the battery pack if damaged;
- Replace the battery pack if damaged;
- Do not charge the battery in ambient conditions below 10°C (50°F);
- Dispose properly.



Connecting the SHUTTLE® iOn using the dry contact input:



Make sure the switch, relay or home automation output is based on dry contact / potential free.

The Shuttle® iOn can be easily connected to Home automation systems or manual switches using the dry contact inputs on the RJ45 port of the motor.

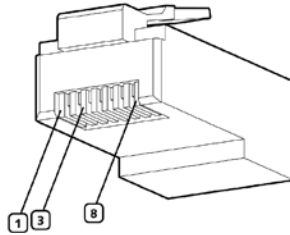
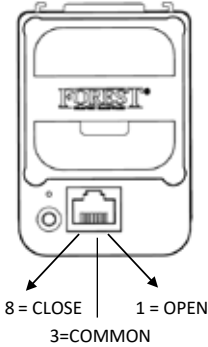

PIN	Port
1	OPEN
2	-
3	COMMON
4	-
5	-
6	-
7	-
8	CLOSE

OPEN: Pin 1 is connected to pin 3 the motor will open the curtain

CLOSE: Pin 8 is connected to pin 3 the motor will close the curtain

STOP: Pin 1 and 8 are connected to pin 3 the motor will stop moving the curtain

Different dry contact modes: (See page 6 on how to change the dry contact mode behaviour)

Depending on the building automation hardware used, different types of dry contact modes are available.

- **Pulse mode:** When short contact is made between the pins the curtain will fully open or close
- **Continuous mode:** The curtain will move as long as the contact is made (mostly used for Home Automation)
- **Single button switch mode:** Every contact made between pin 3(COMMON) and pin 1 or 8 will trigger; open -> close -> stop -> open -> close -> stop -> etc....

Advanced settings

Explanation of the menu settings:

Presses	LEDs 1 2 3 4	Function	Factory default
1	■□□□	Speed Normal 14 cm/s	●
2	□■□□	Speed High 17 cm/s	
3	□□■□	RF 433MHz remote pairing mode	
4	□□□■	Reset Open & Close position	
5	■□□□	Dry contact pulse input	●
6	□■□□	Dry contact continuous input	
7	□□■□	Dry contact single switch input	
8	□□□■	Touch control sensitivity High	●
9	■□□□	Touch control sensitivity Low	
10	□■□□	Touch control Off	
11	□□■□	N/A	
12	□□□■	N/A	
13	■□□□	N/A	
14	□■□□	Adjust Open Position (Stackback)	
15	□□■□	Reverse motor direction	
16	□□□■	Factory Reset (default settings)	

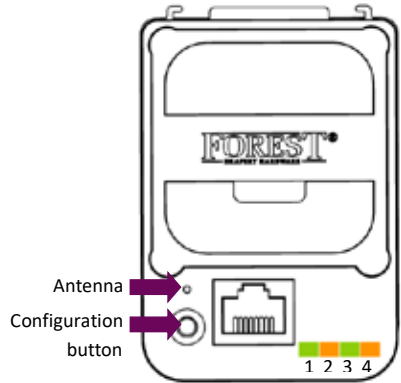

1 & 2: Speed Setting

Standard speed setting is 14cm/s. This can be increased to 17cm/s. Press the configuration button 2 times. To confirm, press and hold the button down a 3rd time for at least 4 seconds; the led will blink 3 times and turn OFF.

3: Pairing / Erasing mode for 433MHz RF remote

Programming Forest RF remote channel: Press the configuration button 3 times and hold it down the 4th time for 4 seconds - LED will start blinking for 10 seconds - Within these 10 seconds press the OPEN button on the selected channel on the remote to pair the remote with the Shuttle® iOn motor.

Erasing a RF remote channel: Same procedure as mentioned above but press CLOSE instead of OPEN to erase the paired RF remote channel.

4: Reset / setting end limits

To reset the end limits: Make sure the curtain is in the open position first. Now press the configuration button 4 times and hold it down the 5th time for 4 seconds until the led blinks 3 times and turns OFF. Remove the battery and after 5 seconds re-insert the battery. Now the limits have been erased; for setting the limits again refer to page 3 section 7 of this manual.

5, 6 & 7: Dry contact input modes

Default mode is Pulse contact. To switch to continuous or single switch mode, press configuration button 6 or 7 times respectively; press and hold once more for 4 seconds until the led blinks 3 times and turns OFF. Please see page 5 for detailed explanation on input modes. Make sure the contact is dry / free of potential (no power on the cable).

8, 9 & 10: Touch Impulse modes

The Shuttle® iOn recognizes when the curtain is pulled by hand to open or close. The Shuttle® iOn will then open or close the curtain all the way. Default setting is high sensitive. Touch Impulse can be set to less sensitive or off, with 9 or 10 presses respectively. To confirm, press and hold once more for 4 seconds until the led blinks 3 times and turns OFF.

14: Adjust open position (stack back)

Press the button 14 times and hold it down the 15th time for 4 seconds. This function creates a 10 second timeframe in which the open position of the curtain can be adjusted. This is particularly easy when the curtains are too tightly squeezed together.

15: Reverse Motor direction

This function easily reverses the motor direction when the motor opens instead of closes, after having given the close command on the remote control. To do so, press the configuration button 15 times and hold it down the 16th time for 4 seconds.

16: Factory Reset

For a full reset of all settings, press configuration button 16 times and hold it down the 17th time for 4 seconds until the led blinks 3 times and turns OFF. Remove the battery and after 5 seconds re-insert the battery.

Technical specification FOREST SHUTTLE® iOn:

Shuttle® iOn Motor

Article Number:	White: 5234000000-1 (incl battery) Black: 5234006000-1 (incl battery)
Voltage Shuttle® iOn:	14.4Vdc
Max. power:	30W
Torque:	1Nm
Frequency:	433.92 MHz
Speed 1: Normal	14 cm/s (5.51"/s)
Speed 2: High	17 cm/s (6.69"/s)
Speed 3: Battery low	6 cm/s (2.36"/s)
Max. curtain weight:	25kg (straight track)
Max. track length:	8 meter (33ft) 1 bend 5 meter (16ft) 2 bends
Shuttle® iOn dimensions:	74 x 50 x 317mm (2.91 x 1.97 x 12.48")
Net weight motor:	1160 grams
Protection degree:	IP20
Max. running time (in one direction):	150 sec
Sound level:	< 41dB
Ambient temperature:	0 - 40°C (32 - 104°F)
Relative humidity:	10 – 80%
Maximum useable altitude above sea level:	2000m (6561ft.)
Certification & Marking:	CE

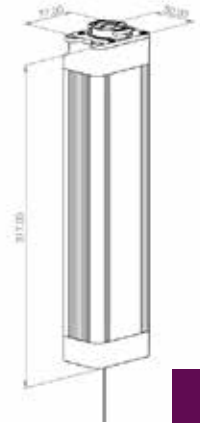

	H	B1	B2
Shuttle iOn	317mm	73.7mm	50.5mm

EN

Technical specification BATTERY CHARGER:

Battery charger	EU	UK	US	AUS
Forest article number:	5234000002	5234000003	5234000004	5234000005
Model:	KS39DU-1680100CE	KS39DU-1680100CB	KS39DU-1680100CU	KS39DU-1680100CA
Input:	100 - 240V~ 50 - 60Hz - 2.0A	100 - 240V~ 50 - 60Hz - 2.0A	100 - 240V~ 50 - 60Hz - 2.0A	100 - 240V~ 50 - 60Hz - 2.0A
Output:	16.8 V DC - 1.0A	16.8 V DC - 1.0A	16.8 V DC - 1.0A	16.8 V DC - 1.0A
Insulation Class:	II	II	II	II
Certification & Marking	CE	CE	UL	SAA
Efficiency Level	VI	VI	VI	VI

Technical specification BATTERY PACK:

Battery pack	White	Black
Forest article number:	5234000001-1	5234006001-1
Battery type:	4-Cell Lithium iOn	4-Cell Lithium iOn
Nominal Voltage:	14.4V	14.4V
Capacity:	3.35Ah	3.35Ah
Certification & Marking:	CE	CE
Operation temperature:	0°C to +40°C (32°F to 104°F)	0°C to +40°C (32°F to 104°F)
Net weight battery pack:	250 gr. (0.55 lbs)	250 gr. (0.55 lbs)

Track applications **FOREST SHUTTLE® iOn:**

The Forest Shuttle® iOn motor can be used exclusively on the following original Forest motorised track systems:
FMS+® / FMS+® Recess / MRS® Motorised Rod System / DS-XL® Motorised / DS-XL® LED Motorised



The Forest Shuttle® iOn is not suitable for humid spaces, like bathrooms or outdoor use.

It is important for the safety of persons to follow these instructions. Save these instructions for future reference.

Do not use the product for any other purpose than intended. In order for the Forest Shuttle® iOn motor to function correctly and safely, the complete curtain system must be assembled with original parts and devices of Forest Group Nederland B.V. This includes all components of the curtain track and battery charger.

Forest Group does not assume liability for resulting damages to property or personal injury, defects, labour on location, service calls, reinstallation or expenses involved shipping, packing or returning goods, if the product has been abused/modified in any way, damaged by improper use or failure to observe these operating instructions. The warranty/guarantee will then expire!

Do not allow children to play with the system or controls. Keep remote controls away from children.

Frequently examine the installation for imbalance and signs of wear or damage. Do not use if repair or adjustment is necessary.

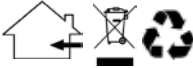

Environment: We recommend that you return a faulty battery pack to your local battery disposal, in accordance with the local environmental regulations for collecting and processing batteries.

